

Since
1972



KİLİT

Güvenliđi teknoloji ile
buluřturan tecrübe...

Ürün Katalođu

www.yumakilit.com.tr





TÜRKİYE'NİN TEK YERLİ ASMA KİLİT ÜRETİCİSİ

Türkiye'de kilit sektörünün önde gelen markalarından **YUMA KİLİT**, faaliyetine 1972 yılında başlamıştır. Yarım asıra yaklaşan tecrübesi, kaliteden ödün vermeyen üretim anlayışı, rekabetçi ve dinamik yapısı ile sanayi üretimine önemli katkılar sağlamaktadır.

YUMA KİLİT Ar-Ge çalışmaları, son teknoloji makina parkuru, insan hatasından arındırılmış bilgisayar kontrollü otomasyona dayalı üretim sistemi ile sürekli kendini geliştirmektedir. Üretim ve ürün geliştirme alanlarında yeni projeler tasarlamakta ve hayata geçirmektedir.

Tamamen yerli kaynaklar ve sermayesiyle, tüm üretim aşamaları yurt içinde tamamlanan ürünleri ile ezber bozarak ucuz ve kalitesiz ithal malları yurtiçi pazardan silmiş, kaliteyi en uygun şartlarda tüketiciye ulaştırmıştır.

Ticari ahlak ve müşteri memnuniyetini temel prensip edinen **YUMA KİLİT**, markasına duyulan güvenin haklı gururunu yaşamaktadır.

TAMAMEN YERLİ SERMAYE

Bütünüyle yerli kaynaklar ve sermaye ile üretilen ve tüm üretim aşamaları yurt içinde tamamlanan Yuma Kilit ürünleri yerli pazardaki güvenlik ve hizmet ihtiyaçlarına en iyi çözümü üretmektedirler.

GÜVENLİK VE KALİTE

Yuma Kilit ürünleri üst düzey güvenlikte devamlılığın sağlanması için özenle geliştirilip sürekli test edilmekte ve en disiplinli kalite standartları çerçevesinde üretilmektedir.

TEK ANAHTAR SİSTEMİ

Tek anahtar sistemine geçtiğinizde üst düzey güvenliği en pratik şekilde sağlayabilirken aynı zamanda güvenlik önlemlerinizi maksimum düzeyde alıyor olmanın rahatlığını taşıyacaksınız.



PİRİNÇ ASMA KİLİTLER

BRASS PADLOCK



Pass Anahtar Sistemi
Key Alike Available



TS EN 12320



Teknik Özellikler

- Darbe, Paslanma ve Çürümelere Karşı Dayanıklı MS 58 Pirinç Gövde, Silindir ve Pimler
- Çekiçle Darbeye ve Koparmaya Dayanıklı Kanca Kilitleme Mekanizması.
- Standart Krom Kaplama Çelik Kanca/ Paslanmaz Çelik Kanca.
- Paslanmaz Yaylar
- Ts-En 12320 Standardında Tse Belgeli (2032 Ve 2032I Hariç)
- Opsiyonel Pass veya Master Sistem

Specifications

- Euro Norm MS 58 Brass Body And Plug Durable Against Damage and Corrosion
- Shackle Bolt Resist Damage-break
- Standard Chrome Plated Shackle/inox (Stainless Steel) Shackle
- Inox (Stainless Steel) Springs
- Ts-en 12320 Tse Certificated (Except 2032 and 2032I)
- Pass Or Master System Available



****2050-2050ML-2050L-2040-2040L kodlu ürünlerin kancası opsiyonel olarak paslanmaz çelikten yapılabilir.**

STANDART PİRİNÇ ASMA KİLİTLER • STANDARD BRASS PADLOCK

Model Code	Ürün Cinsi Description	Koli İçi Adet Bundle Piece	Ölçüler Dimentions						Birim Ağırlık Unit Weight
			a	b	c	d	e	f	
YM 2032	32 mm Asma Kilit	144	32	30	5	18	18	13	103 gr.
YM 2040	40 mm Asma Kilit	120	40	35	6	24	22	15	169,5 gr.
YM 2050	50 mm Asma Kilit	60	50	40	8	30	28	17	265 gr.
YM 2060	60 mm Asma Kilit	60	60	45	9	31	34	18	382,5 gr.
YM 2063	63 mm Asma Kilit	60	63	49	10	33	33	20	477,5 gr.

ORTA UZUN KANCALI PİRİNÇ ASMA KİLİTLER * SEMI-LONG SHACKLE BRASS PADLOCK

Model Code	Ürün Cinsi Description	Koli İçi Adet Bundle Piece	Ölçüler Dimentions						Birim Ağırlık Unit Weight
			a	b	c	d	e	f	
YM 2040ML	40 mm Asma Kilit Orta Uzun Kanca	120	40	35	6	36	22	15	170 gr.
YM 2050ML	50 mm Asma Kilit Orta Uzun Kanca	60	50	40	8	42	28	17	270 gr.

UZUN KANCALI PİRİNÇ ASMA KİLİTLER • LONG SHACKLE BRASS PADLOCK

Model Code	Ürün Cinsi Description	Koli İçi Adet Bundle Piece	Ölçüler Dimentions						Birim Ağırlık Unit Weight
			a	b	c	d	e	f	
YM 2032 L	32 mm Asma Kilit Uzun Kanca	120	32	30	5	46	18	13	108,5 gr.
YM 2040 L	40 mm Asma Kilit Uzun Kanca	120	40	35	6	62	22	15	181 gr.
YM 2050 L	50 mm Asma Kilit Uzun Kanca	60	50	40	8	78	28	17	300 gr.
YM 2060 L	60 mm Asma Kilit Uzun Kanca	60	60	45	9	80	34	18	420 gr.

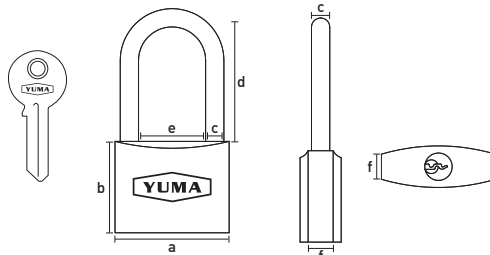

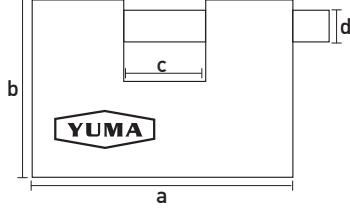

Teknik Özellikler

- MS 58 Piriç/Çelik Gövde Ve Piriç Silindir.
- Çekiçle Darbeye ve Koparmaya Dayanıklı Kanca Kilitleme Mekanizması
- Standart Krom Kaplama Çelik Kanca/ Paslanmaz Kanca.
- Paslanmaz Yaylar
- Ts En 12320 Standardında Tse Belgeli
- Opsiyonel Pass veya Master Sistem.

Specifications

- Steel/brass Body, Brass Plug and Pins.
- High Anti-theft Bolt Mechanism.
- Standard Steel Shackle Chrome Plated/ Inox (Stainless Steel) Shackle.
- Stainless Steel Springs.
- TS EN 12320 Certificated.
- Optional Pass or Master System.

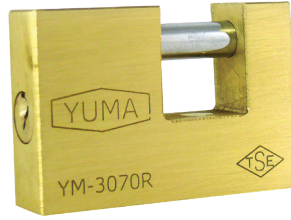
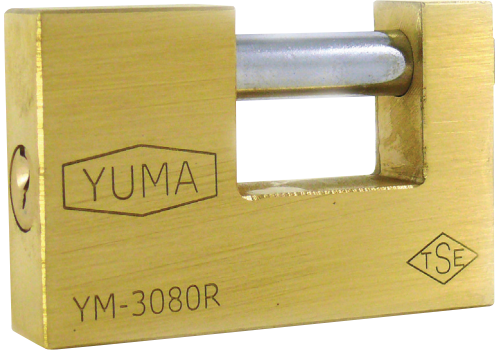

PIRİNÇ KAYAR MİLLİ ASMA KİLİTLER • BRASS RECTANGULAR PADLOCK

Model Code	Ürün Cinsi Description	Koli İçi Adet Bundle Piece	Ölçüler Dimentions				Birim Ağırlık Unit Weight
			a	b	c	d	
YM 3070	70 mm Kayar Millî Asma Kilit	48	70	52	23	10	443 gr.
YM 3080	80 mm Kayar Millî Asma Kilit	48	80	52	33	10	476,5 gr.
YM 3068	68 mm Kayar Millî Asma Kilit	48	68	52	26	10	417,5 gr.
YM 3079	79 mm Kayar Millî Asma Kilit	48	79	52	33	10	464 gr.

PASLANMAZ KANCALI KAYAR MİLLİ ASMA KİLİTLER * STAINLESS STEEL SHACKLE BRASS RECTANGULAR PADLOCKS

Model Code	Ürün Cinsi Description	Koli İçi Adet Bundle Piece	Ölçüler Dimentions				Birim Ağırlık Unit Weight
			a	b	c	d	
YM 3070I	70 mm Kayar Millî Paslanmaz Kancalı	48	70	52	23	10	443 gr.
YM 3080I	80 mm Kayar Millî Paslanmaz Kancalı	48	80	52	33	10	476,5 gr.
YM 3068I	68 mm Kayar Millî Paslanmaz Kancalı	48	68	52	26	10	417,5 gr.
YM 3079I	79 mm Kayar Millî Paslanmaz Kancalı	48	79	52	33	10	464 gr.

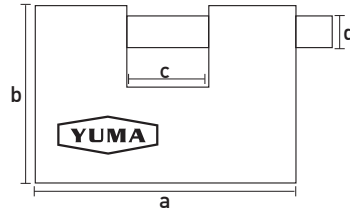

Teknik Özellikler

- Sfero Döküm Gövde
- MS 58 Piriç Silindir
- Standart Krom Kaplama Çelik Kanca
- Paslanmaz yaylar

Specifications

- Cast Iron Body
- MS 58 Brass Plug
- Standard Steel Shackle Chrome Plated
- Stainless Steel Springs.

KAYAR MİLLİ DÖKÜM ASMA KİLİT * RECTANGULAR CAST IRON PADLOCK

Model Code	Ürün Cinsi Description	Koli İçi Adet Bundle Piece	Ölçüler Dimentions				Birim Ağırlık Unit Weight
			a	b	c	d	
YM 1060R	60 mm Kayar Millî Döküm Asma Kilit	48	70	50	23	10	400 gr
YM 1070R	70 mm Kayar Millî Döküm Asma Kilit	48	80	50	26	10	441 gr
YM 1080R	80 mm Kayar Millî Döküm Asma Kilit	36	80	53	31	10	493 gr
YM 1090R	90 mm Kayar Millî Döküm Asma Kilit	36	90	57	37	10	594 gr



Teknik Özellikler

- Sfero Döküm Gövde
- MS 58 Pirinç Silindir ve Pimler
- Standart Krom Kaplama Çelik Kanca
- Sızdırmazlık Contası
- Çift Sürgülü Kilitleme Mekanizması

Specifications

- Cast Iron Padlock Body Durable Against Damage
- MS 58 Brass Plug and Pins
- Standard Steel Shackle Chrome Plated
- Shackle Oring Resist Corrosion
- Double Bold Locking System

Model Code	Ürün Cinsi Description	Koli İçi Adet Bundle Piece	Ölçüler Dimentions						Birim Ağırlık Unit Weight
			a	b	c	d	e	f	
YM 1020	20 mm Gri Döküm Kilit	600	21	20	3,3	11	10	11	32,5 gr.
YM 1025	25 mm Gri Döküm Kilit	480	25	25	4,3	13,5	13	13	50 gr.
YM 1032	32 mm Gri Döküm Kilit	240	32	30	5,3	16,5	17	15	96 gr.
YM 1038	38 mm Gri Döküm Kilit	120	38	35	6,3	22	20	18	147 gr.
YM 1050	50 mm Gri Döküm Kilit	60	50	43	9	25	25	23	315 gr.
YM 1063	63 mm Gri Döküm Kilit	30	63	52	10,5	33	33	26,5	546 gr.
YM 1032 L	32 mm Gri Döküm Uzun Kanca Kilit	240	32	30	5,3	46	17	15	108 gr.
YM 1038 L	38 mm Gri Döküm Uzun Kanca Kilit	120	38	35	5,3	57	17	15	168 gr.
YM 1050 L	50 mm Gri Döküm Uzun Kanca Kilit	60	50	43	9	60,5	25	23	352 gr.





Teknik Özellikler

- Sfero Döküm Gövde
- MS 58 Pirinç Silindir ve Pimler
- Standart Krom Kaplama Çelik Kanca
- Sızdırmazlık Contası
- Çift Sürgülü Kilitleme Mekanizması

Specifications

- Cast Iron Padlock Body Durable Against Damage
- MS58 Brass Plug And Pins
- Standard Chrome Plated Steel Shackle
- Shackle Oring Resist Corrosion
- Double Bolt Locking System

Model Code	Ürün Cinsi Description	Koli İçi Adet Bundle Piece	Ölçüler Dimentions						Birim Ağırlık Unit Weight
			a	b	c	d	e	f	
YM 1025 B	25 mm Sarı Boyalı Döküm Kilit	480	25	25	4,3	13,5	13	13	50 gr.
YM 1032 B	32 mm Sarı Boyalı Döküm Kilit	240	32	30	5,3	16,5	17	15	96 gr.
YM 1038 B	38 mm Sarı Boyalı Döküm Kilit	120	38	35	6,3	22	20	18	147 gr.
YM 1050 B	50 mm Sarı Boyalı Döküm Kilit	60	50	43	9	25	25	23	315 gr.
YM 1063 B	63 mm Sarı Boyalı Döküm Kilit	36	63	52	10,5	34	33	26,5	546 gr.
YM 1032 BL	32 mm Sarı Boyalı Döküm Uzun Kanca Kilit	240	32	30	5,3	46	17	15	108 gr.
YM 1038 BL	38 mm Sarı Boyalı Döküm Uzun Kanca Kilit	120	38	35	6,3	57	20	28	168 gr.
YM 1050 BL	50 mm Sarı Boyalı Döküm Uzun Kanca Kilit	60	50	43	9	60,5	25	23	352 gr.



ŞİFRELİ PİRİNÇ ASMA KİLİT COMBINATION BRASS PADLOCK

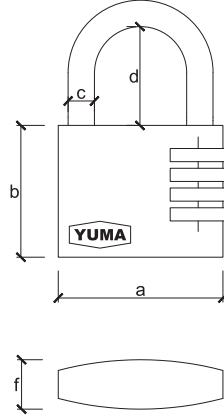

Teknik Özellikler

- Darbe, Paslanma ve Çürümelere Karşı Dayanıklı MS 58 Pirinç Gövde, Silindir ve Pimler
- Standart Krom Kaplama Çelik Kanca
- Paslanmaz Yaylar

Specifications

- Steel/Brass Body, Brass Plug and Pins Durable Against Damage and Corrosion.
- Standard Steel Shackle Chrome Plated.
- Stainless Steel Springs.

ŞİFRELİ PİRİNÇ ASMA KİLİT * COMBINATION BRASS PADLOCK

Model Code	Ürün Cinsi Description	Koli İçi Adet Bundle Piece	Ölçüler Dimentions						Birim Ağırlık Unit Weight
			a	b	c	d	e	f	
YM 2120	20mm Şifreli Asma Kilit 3 Basamaklı	240	20	30	3	9	11	10	61 gr
YM 2125	25mm Şifreli Asma Kilit 3 Basamaklı	240	25	30	3,8	22	11,5	11	79 gr
YM 2130	30mm Şifreli Asma Kilit 3 Basamaklı	120	30	31	4	22,5	17	11	90 gr
YM 2140	40mm Şifreli Asma Kilit 4 Basamaklı	120	40	40	5	32	25	12	160 gr
YM 2150	50mm Şifreli Asma Kilit 4 Basamaklı	60	50	46	6	35	31,5	13,5	266 gr

ELEKTRİKLİ KAPI KARŞILIĞI / BAS AÇ ELECTRICAL DOOR OPENER

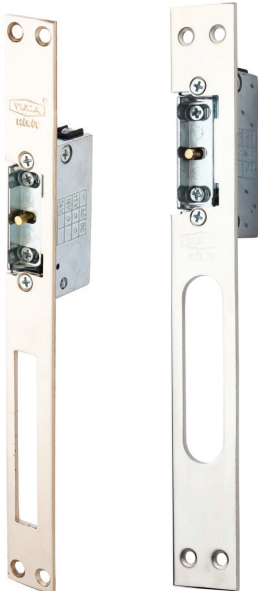

Model Code	Ürün Cinsi Description	Koli İçi Adet Bundle Piece	Birim Ağırlık Unit Weight
YM 717	Elektrikli Kapı Karşılığı	24	286 gr.
YM 718	Monoblok Elektrikli Kapı Karşılığı	24	282 gr.
YM 750	Tirajlı Bas-Aç	24	325 gr.



Teknik Özellikler

- Galvaniz Sac Gövde
- Nikel Kaplamalı Kare Ayna ve Karşılık
- Opsiyonel: Oval-Krom/Saten/Sarı Kaplama Ayna
- Zamak Sürgü ve Mandal

Specifications

- Galvanized Sheet Metal Case.
- Nickel Plated Square Forehead and Striking
- Striking (Optional: Ovoid-Chrome/Satin/Gold Plated)
- Zinc Alloy Deadbolt and Latch



TS EN 12209

- * Tüm Gömme Kilitlerde Dar Ayna (e=18mm) Opsiyonu Vardır.
- * Narrow Type (e=18mm) Forehead Option Is Available For All Mortise Locks.

SİLİNDİRLİ GÖMME DAİRE KİLİTLERİ * MORTISE LOCK WITH CYLINDER

Model Code	Ürün Cinsi Description	Koli İçi Adet Bundle Piece		Ölçüler Dimentions						Birim Ağırlık Unit Weight
		a	b	c	d	e	f			
YM 635	35x85mm Daire Kilidi	30	35	240	176	85	23	2	770 gr	
YM 640	40x85mm Daire Kilidi	30	40	240	176	85	23	2	800 gr	
YM 645	45x85mm Daire Kilidi	30	45	240	176	85	23	2	820 gr	
YM 620	20x85mm AL. Pvc Doğrama Gömme Kilidi	30	20	240	173	85	23	2	604 gr	
YM 625	25x85mm AL. Pvc Doğrama Gömme Kilidi	30	25	240	173	85	23	2	622 gr	
YM 645.3M	45x85mm 3 Millli Daire Kilidi	30	45	240	176	85	23	2	868 gr	

İÇ KAPI ODA-WC GÖMME KİLİTLER * INTERIOR MORTISE LOCK

Model Code	Ürün Cinsi Description	Koli İçi Adet Bundle Piece		Ölçüler Dimentions						Birim Ağırlık Unit Weight
		a	b	c	d	e	f			
YM 607	40x90mm WC Kilidi	40	40	240	176	85	23	2	612 gr	
YM 604	35x90mm Oda Kilidi	40	35	240	176	90	23	2	586,5 gr	
YM 613	40x90mm Oda Kilidi	40	40	240	176	90	23	2	612 gr	
YM 617	40x72mm WC Kilidi	40	40	230	153	72	23	2	440 gr	
YM 618	40x72mm Oda Kilidi	40	40	230	153	72	23	2	440 gr	
YM614	45x90mm Oda Kilidi	40	45	240	176	90	23	2	625 gr	
YM615	45x90mm Wc Kilidi	40	45	240	176	90	23	2	625 gr	

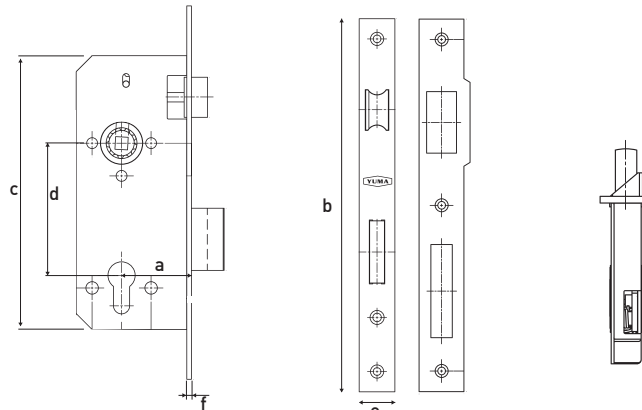

CERMAN BAREL / SİLİNDİR

BRASS CYLINDER / NORMAL KEY



Pass Sistem Anahtar
Key Alike Available



TS EN 1303



Teknik Özellikler

- Euro Norm MS 58 pirinç profil silindir ve Pimler
- Sinter Döküm Kam
- Paslanmaz Yaylar
- Dijital Teknoloji Anahtar Kombinasyonu
- Hırsızlığa Karşı Opsiyonel Tuzak Sistemi
- Saten / Nikel / Antik Kaplama Gövde
- Opsiyonel Pass veya Master Sistem

Specifications

- Euro norm MS 58, brass profile, plug and Pins
- Sintered Cam
- Inox (Stainless Steel) Springs
- Digital Key Combination
- Trap/Pass/Master System Available
- Satin/Nickel/Antique Plating Optional



Model Code	Ürün Cinsi Description	Koli İçi Adet Bundle Piece	Ölçüler Dimentions				Birim Ağırlık Unit Weight
			a	b	c	d	
YM B68	68 mm Cerman Barel	120	68	26	10	32	223 gr.
YM B68T	68 mm Cerman Barel Tuzaklı	120	68	26	10	32	223 gr.
YM B68S	68 mm Cerman Barel Saten	120	68	26	10	32	223 gr.
YM B41S	41 mm Cerman Yarım Barel Saten	120	41	26	10	5	141 gr.
YM B55S	55 mm Cerman Yarım Barel Saten	120	55	40	10	5	177 gr.
YM B62	62 mm Cerman Barel	120	62	26	10	26	210 gr.
YM B70	70 mm Cerman Barel	120	70	30	10	30	228 gr.
YM B83S	83 mm Cerman Barel Saten	96	83	33	10	40	267 gr.
YM B90S	90 mm Cerman Barel Saten	96	90	35	10	45	288 gr.
YM B100	100 mm Cerman Barel	72	100	40	10	50	316 gr.

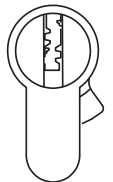
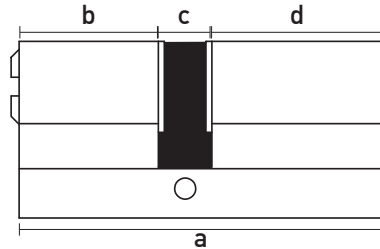
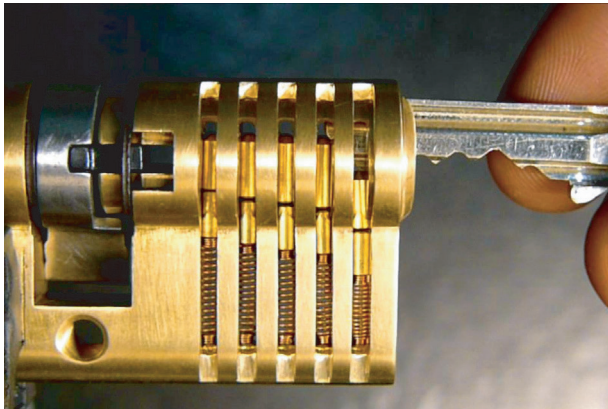

Pass Sistem Anahtar
Key Alike Available

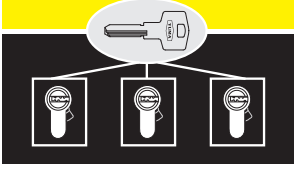

TS EN 1303



Teknik Özellikler

- Euro Norm MS 58 pirinç profil silindir ve Pimler
- Sinter Döküm Kam
- Paslanmaz Yaylar
- Dijital Teknoloji Anahtar Kombinasyonu
- Hırsızlığa Karşı Opsiyonel Tuzak Sistemi
- Saten / Nikel / Antik Kaplama Gövde
- Opsiyonel Pass veya Master Sistem

Specifications

- Euro Norm MS 58, Brass Profile, Plug and Pins
- Sintered Cam
- Inox (Stainless Steel) Springs
- Digital Key Combination
- Trap/Pass/Master System Available
- Satin/Nickel/Antique Plating Optional

Model Code	Ürün Cinsi Description	Koli İçi Adet Bundle Piece	Ölçüler Dimentions				Birim Ağırlık Unit Weight
			a	b	c	d	
YM B68B	68 mm Bilyalı Barel	50	68	26	10	32	263 gr.
YM B68BT	68 mm Bilyalı Barel Tuzaklı	50	68	26	10	32	264 gr.
YM B68BS	68 mm Bilyalı Barel Saten	50	68	26	10	32	263 gr.
YM B68BTS	68 mm Bilyalı Barel Tuzaklı Saten	50	68	26	10	32	264 gr.
YM B90BS	90mm Bilyalı Barel Saten	96	90	35	10	45	300 gr.

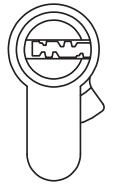
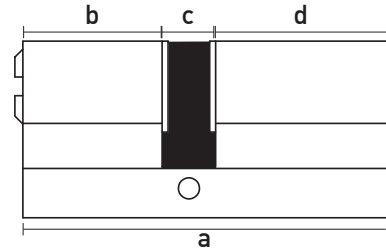

BAREL (MANDALLI MODEL) KNOB CYLINDER



Pass Sistem Anahtar
Key Alike Available



TS EN 1303



Teknik Özellikler

- Euro Norm MS 58 pirinç profil silindir ve Pimler
- Sinter Döküm Kam
- Paslanmaz Yaylar
- Dijital Teknoloji Anahtar Kombinasyonu
- Hırsızlığa Karşı Opsiyonel Tuzak Sistemi
- Saten / Nikel / Antik Kaplama Gövde
- Opsiyonel Pass Veya Master Sistem

Specifications

- Euro Norm MS 58, Brass Profile, Plug and Pins
- Sintered Cam
- Inox (Stainless Steel) Springs
- Digital Key Combination
- Trap/Pass/Master System Available
- Satin/Nickel/Antique Plating Optional

Model Code	Ürün Cinsi Description	Koli İçi Adet Bundle Piece	Ölçüler Dimentions				Birim Ağırlık Unit Weight
			a	b	c	d	
YM B68M	68 mm Cerman Barel Mandallı	30	68	26	10	32	240 gr.
YM B68MS	68 mm Cerman Barel Mandallı Saten	30	68	26	10	32	240 gr.
YM B41MS	41 mm Mandallı Barel Saten	120	41	5	10	26	117 gr.
YM B68BM	68 mm Bilyalı Barel Mandallı	30	68	26	10	32	254 gr.
YM B68BTM	68 mm Bilyalı Barel Tuzaklı Mandallı	30	68	26	10	32	252 gr.
YM B68BMS	68 mm Bilyalı Barel Mandallı Saten	30	68	26	10	32	254 gr.
YM B68BTMS	68 mm Bilyalı Barel Tuzaklı Mandallı Saten	30	68	26	10	32	251 gr.
YM B68BG	68 mm Çelik Kapı Barel Seti Tuzaklı	20	68	26	10	32	454 gr.
YM B68BGS	68 mm Çelik Kapı Barel Seti Tuzaklı Saten	20	68	26	10	32	454 gr.
YM B68G	68 mm Cerman Çelik Kapı Barel Seti Tuzaklı	20	68	26	10	32	454 gr.
YM B70MS	70 mm Cerman Mandallı Barel Saten	-	70	30	10	30	245 gr.
YM B90MS	90 mm Cerman Mandallı Barel Saten	80	90	35	10	45	275 gr.
YM B90BMS	90 mm Bilyalı Mandallı Barel Saten	80	90	35	10	45	287 gr.
YM B76KB	76mm Kuyruklu Barel / 76mm Tailed Barel	50	76	26	10	40	303gr.
YM B100MS	100mm Cerman Mandallı Baren Saten	80	100	40	10	50	322gr.

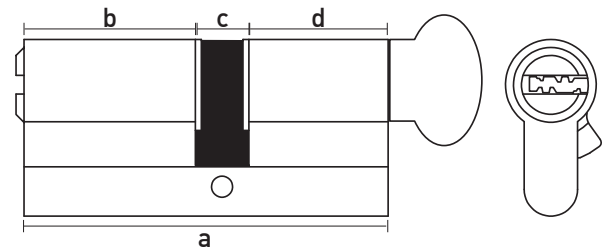
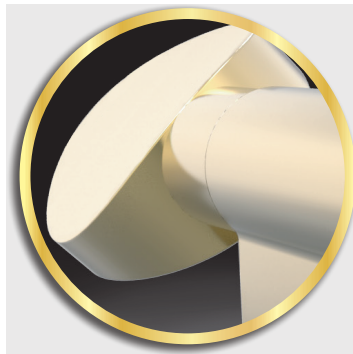
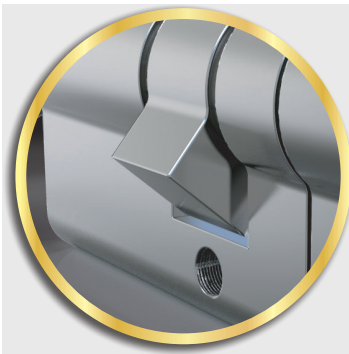



TS EN 1303



Teknik Özellikler

- Euro Norm MS 58 Pirinç Profil Silindir ve Pimler
- 6 Pim
- Sinter Döküm Kam
- Paslanmaz Yaylar
- Dijital Teknoloji Anahtar Kombinasyonu
- Hırsızlığa Karşı Opsiyonel Tuzak Sistemi
- Saten / Nikel / Antik Kaplama Gövde
- Opsiyonel Pass veya Master Sistem

Specifications

- Euro Norm MS 58, Brass Profile, Plug and Pins
- 6 Pins
- Sintered Cam
- Inox (Stainless Steel) Springs
- Digital Key Combination
- Optional Anti-theft Trap System
- Trap / Pass / Master System Available
- Satin/ Nickel / Antique Plating Optional

Model Code	Ürün Cinsi Description	Koli İçi Adet Bundle Piece	Ölçüler Dimentions				Birim Ağırlık Unit Weight
			a	b	c	d	
YM B68BNP6	68mm Bilyalı Barel 6 Pim	30	68	26	10	32	274 gr.
YM B68BMNP6	68mm Bilyalı Mandallı Barel 6 Pim	30	68	26	10	32	264,5 gr.
YM B68BGP6	68mm Çelik Kapı Bilyalı Barel Seti Tuzaklı 6 Pim	20	68	26	10	32	461 gr.

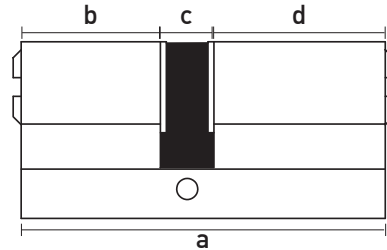
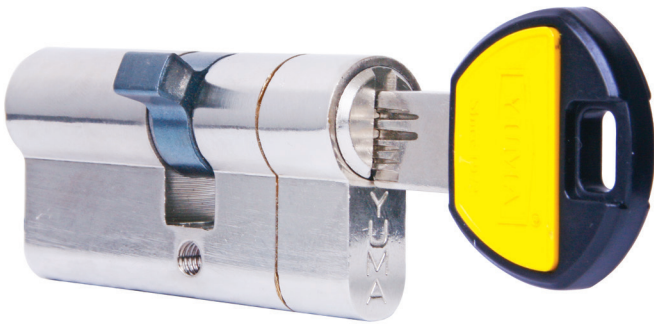

TİRAJLI KİLİTLER

RIM LOCKS



TS EN 12209



Teknik Özellikler

- Elektrostatik Siyah Boyalı Sac Gövde, Kasa ve Karşılık
- Zamak Sürgü ve Mandal
- Zamak Kovan
- MS58 Pirinç Silindir
- İki Turlu Sürgü

Specifications

- Electrostatic Black Powder Painted Sheet Metal Case and Striker
- Zinc Alloy Deadbolt ant Latch
- Zinc Alloy Barrel
- MS58 Brass Cylinder
- 2 Throw Dead Bolt

Model Code	Ürün Cinsi Description	Koli İçi Adet Bundle Piece	Birim Ağırlık Unit Weight
YM 600	Tirajlı Kilit Oval Karşılıklı (14 cm)	30	912 gr.
YM 600.1	Tirajlı Kilit Oval Karşılıksız (14 cm)	30	846 gr.
YM 600.3M	Tirajlı Kilit Oval 3 Milli Karşılıklı	30	925 gr.
YM 600.3M.1	Tirajlı Kilit Oval 3 Milli Karşılıksız	30	858 gr.
YM 602	Tirajlı Kilit Kare Karşılıklı (14 cm) / Kırmızı Opsiyonlu	30	900 gr.
YM 602.1	Tirajlı Kilit Kare Karşılıksız (14 cm) / Kırmızı Opsiyonlu	30	835 gr.
YM 601	Tirajlı Kilit Oval Karşılıklı (12 mm)	30	820 gr.
YM 601.1	Tirajlı Kilit Oval Karşılıksız (12 mm)	30	759 gr.
YM 608	Tirajlı Borulu Barel	120	126 gr.

ELEKTRİKLİ TİRAJLI KAPI OTOMATI

ELECTRICAL RIM LOCK



Teknik Özellikler

- Elektrostatik Boyalı Sac ve Alüminyum Kasa
- MS58 Pirinç Barel ve Silindir
- 12 VAC Voltaj
- Zamak Çelik Makara

Specifications

- Electrostatic Black Powder Painted Sheet Metal and Aluminium Case
- MS58 Brass Cylinder and Barrel
- 12 VAC Voltaj
- Zinc Alloy and Steel Roller

Model Code	Ürün Cinsi Description	Koli İçi Adet Bundle Piece	Birim Ağırlık Unit Weight
YM 609	Elektrikli Tirajlı Kilit	12	1130 gr.
YM 610	Otomatik Kapı Açıcı	30	477 gr.
YM 611	Elektrikli Tirajlı Makaralı Kilit	12	1125 gr.
YM 611-U	Elektrikli Tirajlı Uzun Barelili Kilit	12	1130 gr.

KİLİTLİ ÇELİK ROZET * STEEL ARMOR LOCK
ESSİZ
GÜVENLİK
SİSTEMİ

Pass Sistem Anahtarıyla birlikte gelen kilitle çelik rozet ürün eş benzeri bulunmayan üstün güvenlik hizmeti sağlar.

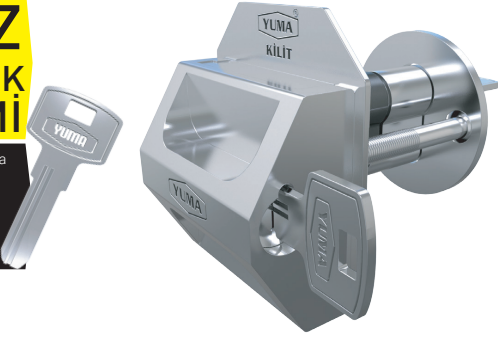

Model Code	Ürün Cinsi Description	Koli İçi Adet Bundle Piece
YM 703	Kilitle Rozet	10
YM 705	Kilitle Rozet + 68 mm Barel Tek Set	10
YM 707	Kilitle Rozet + 83 mm Barel Tek Set	10

ÇELİK KAPI ROZETİ * STEEL DOOR ROSETTE

Model Code	Ürün Cinsi Description	Koli İçi Adet Bundle Piece	Birim Ağırlık Unit Weight
YM 721	Çelik Kapi Rozeti M5 Vidalı	120	162 gr.
YM 722	Çelik Kapi Rozeti İrmak	100	198 gr.
YM 723	Çelik Kapi Rozeti Köşeli	100	225 gr.

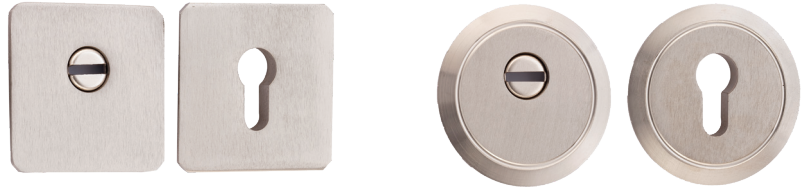
EMNİYET MANDALI * SAFETY LATCH LOCK

Model Code	Ürün Cinsi Description	Koli İçi Adet Bundle Piece	Birim Ağırlık Unit Weight
YM 724	Emniyet Mandalı	360	63 gr.
YM 724D	Emniyet Mandalı Düğmeli	250	72 gr.

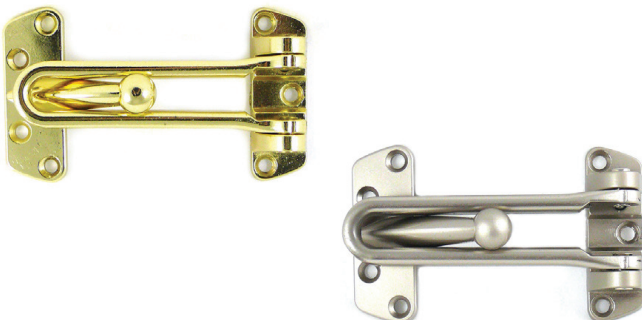
EMNİYET KELEPÇESİ * SECURITY CLAMP

Model Code	Ürün Cinsi Description	Koli İçi Adet Bundle Piece	Birim Ağırlık Unit Weight
YM 701	Emniyet Kelepçesi Kademeli Sarı	60	210 gr.
YM 702	Emniyet Kelepçesi Kademeli Saten	60	210 gr.

PANİK BAR * PANIC BAR



Model Code	Ürün Cinsi Description	Koli İçi Adet Bundle Piece	Birim Ağırlık Unit Weight
YM 716	Panik Bar Yönsüz	35	1528 gr.

**Sağ ve sol uyumludur.

OTO EMNİYET KİLİDİ * AUTO SECURITY LOCK

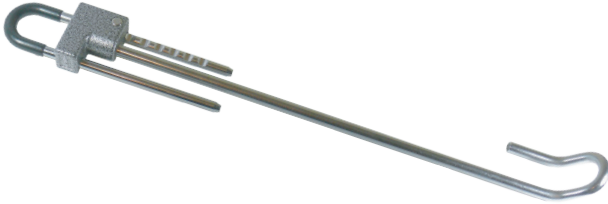

Model Code	Ürün Cinsi Description	Koli İçi Adet Bundle Piece	Birim Ağırlık Unit Weight
YM 710	Oto Emniyet Kilidi	15	1245 gr.

BİSİKLET - MOTOSİKLET KİLİDİ * BICYCLE-MOTORCYCLE LOCK



Model Code	Ürün Cinsi Description	Koli İçi Adet Bundle Piece	Birim Ağırlık Unit Weight
YM 733	Bisiklet Kilidi 12mm x 65cm	120	70 gr
YM 734	Bisiklet Kilidi 12mm x 150cm	80	310 gr
YM 735	Motosiklet Kilidi 20mm x 120cm	24	509 gr
YM 746	Motosiklet Kilidi 20mm x 150cm	20	1100 gr
YM 747	Şifreli Motosiklet Kilidi 20mm x 120cm	24	1050 gr
YM 748	Zincirli Motosiklet Kilidi 10mm x 150cm	6	3000 gr
YM 749	Motosiklet Disk Kilidi	40	375 gr

TRAŞ APARATI * SHAVING APPARATUS



Model Code	Ürün Cinsi Description	Koli İçi Adet Bundle Piece	Birim Ağırlık Unit Weight
YM 403	Tıraş Aparatı	24 Düzine	27 gr

CAM KAPI KÖŞE KİLİDİ * GLASS DOOR LOCK

Model Code	Ürün Cinsi Description	Koli İçi Adet Bundle Piece	Birim Ağırlık Unit Weight
YM 725	Cam Köşe Kilidi	22	949 gr.

KAPI EMNİYET APARATI MİLLİ * SECURITY SHAFT APARATUS

Model Code	Ürün Cinsi Description	Koli İçi Adet Bundle Piece	Birim Ağırlık Unit Weight
YM 730	Kapi Emniyet Aparatı Millî	25	767 gr.

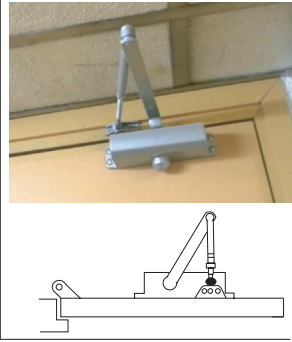
KAPI HİDROLİĞİ * HYDRAULIC DOOR CLOSER

Model Code	Ürün Cinsi Description	Koli İçi Adet Bundle Piece	Yük Kapasitesi Dimentions	Birim Ağırlık Unit Weight
YM 712	2 Numara Kapi Hidroliği	10	25 - 45 kg.	1132 gr.
YM 713	3 Numara Kapi Hidroliği	10	45 - 65 kg.	1912 gr.
YM 714	4 Numara Kapi Hidroliği	10	60 - 85 kg.	2170 gr.

EMNİYET KELEPÇESİ * SECURITY CLAMP

Model Code	Ürün Cinsi Description	Koli İçi Adet Bundle Piece	Birim Ağırlık Unit Weight
YM 729	Kapi İtme Yayı	40	464 gr.

EKO SARI BOYALI DÖKÜM ASMA KİLİTLER ECO YELLOW PAINTED CAST IRON PADLOCKS



Teknik Özellikler

- Sfero Döküm Gövde
- Zamak Silindir
- Piriç Pim
- Standart Krom Kaplama Çelik Kanca

Specifications

- Cast Iron Padlock Body
- Zinc Plug
- Brass Pins
- Standard Steel Shackle Chrome Plated

Model Code	Ürün Cinsi Description	Koli İçi Adet Bundle Piece	a	b	Ölçüler Dimentions				Birim Ağırlık Unit Weight
					c	d	e	f	
YMK 1220B	20 mm Sarı Boyalı Döküm Asma Kilit	600	20	20	3,3	11	10	11	28 gr
YMK 1225B	25 mm Sarı Boyalı Döküm Asma Kilit	600	25	25	3,8	13,5	13	12	44 gr
YMK 1232B	32 mm Sarı Boyalı Döküm Asma Kilit	240	32	28	4,4	16,5	16,5	13	74 gr
YMK 1238B	38 mm Sarı Boyalı Döküm Asma Kilit	240	38	32	5,5	22	20	15	115 gr
YMK 1250B	50 mm Sarı Boyalı Döküm Asma Kilit	120	50	40	7	25	27	18	222 gr
YMK 1263B	63 mm Sarı Boyalı Döküm Asma Kilit	60	63	50	8	33	33	20	378 gr
YMK 1225BL	25 mm Sarı Boyalı Uzun Kancalı Döküm Asma Kilit	600	25	25	3,8	30	13	12	48 gr
YMK 1232BL	32 mm Sarı Boyalı Uzun Kancalı Döküm Asma Kilit	240	32	28	4,4	46	16,5	13	85 gr
YMK 1238BL	38 mm Sarı Boyalı Uzun Kancalı Döküm Asma Kilit	240	38	32	5,5	52,5	20	15	128 gr
YMK 1250BL	50 mm Sarı Boyalı Uzun Kancalı Döküm Asma Kilit	120	50	40	7	52,5	27	18	238 gr
YMK 1263BL	63 mm Sarı Boyalı Uzun Kancalı Döküm Asma Kilit	60	63	50	8	62	33	20	398 gr

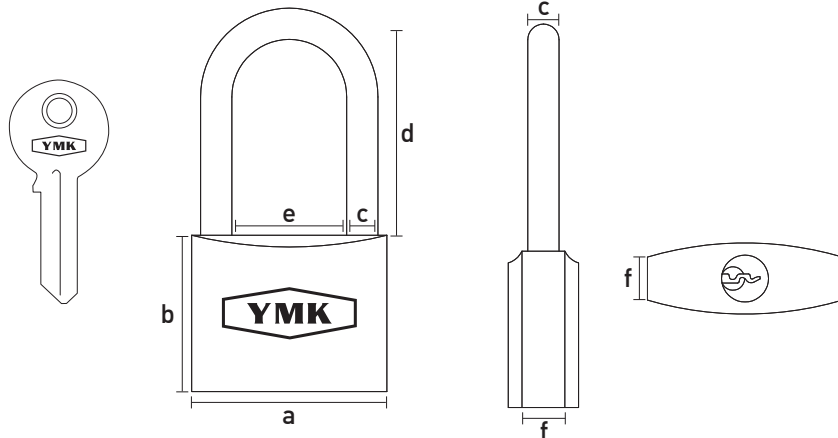



Teknik Özellikler

- Sfero Döküm Gövde
- Zamak Silindir
- Piriç Pim
- Standart Krom Kaplama Çelik Kanca

Specifications

- Cast Iron Padlock Body
- Zinc Plug
- Brass Pins
- Standard Steel Shackle Chrome Plated

Model Code	Ürün Cinsi Description	Koli İçi Adet Bundle Piece	a	b	Ölçüler Dimentions				Birim Ağırlık Unit Weight
					c	d	e	f	
YMK 1220	20 mm Gri Döküm Asma Kilit	600	20	20	3,3	11	10	11	28 gr
YMK 1225	25 mm Gri Döküm Asma Kilit	600	25	25	3,8	13,5	13	12	44 gr
YMK 1232	32 mm Gri Döküm Asma Kilit	240	32	28	4,4	16,5	16,5	13	74 gr
YMK 1238	38 mm Gri Döküm Asma Kilit	240	38	32	5,5	22	20	15	115 gr
YMK 1250	50 mm Gri Döküm Asma Kilit	120	50	40	7	25	27	18	222 gr
YMK 1263	63 mm Gri Döküm Asma Kilit	60	63	50	8	33	33	20	378 gr
YMK 1225L	25 mm Gri Döküm Uzun Kancalı Asma Kilit	600	25	25	3,8	30	13	12	48 gr
YMK 1232L	32 mm Gri Döküm Uzun Kancalı Asma Kilit	240	32	28	4,4	46	16,5	13	85 gr
YMK 1238L	38 mm Gri Döküm Uzun Kancalı Asma Kilit	240	38	32	5,5	52,5	20	15	128 gr
YMK 1250L	50 mm Gri Döküm Uzun Kancalı Asma Kilit	120	50	40	7	52,5	27	18	238 gr
YMK 1263L	63 mm Gri Döküm Uzun Kancalı Asma Kilit	60	63	50	8	62	33	20	398 gr

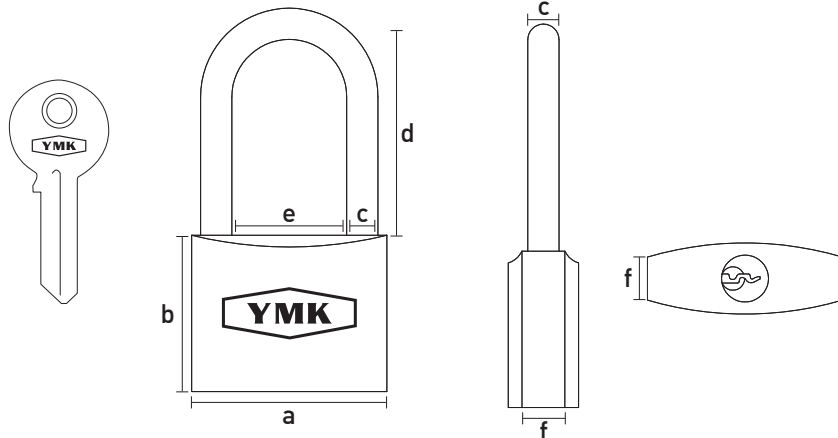

HİBRİT BİLYALI BAREL / SİLİNDİR HYBRID COMPUTER KEY CYLINDER



Pass Sistem Anahtar
Key Alike Available

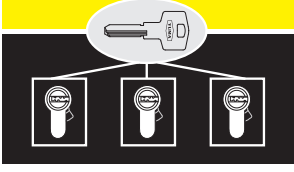

TS EN 1303



Teknik Özellikler

- Piriç Tüp ve Anahtar
- Zamak Gövde
- Paslanmaz Yaylar
- Dijital Teknoloji Anahtar Kombinasyonu
- Saten / Nikel Kaplama Gövde
- Opsiyonel Pass Sistem

Specifications

- Brass Tube and Key
- Zinc Body
- INOX (Stainless Steel) Springs
- Digital Key Combination
- Satin / Nickel Plating Optional
- Pass System Available

Model Code	Ürün Cinsi Description	Koli İçi Adet Bundle Piece	Ölçüler Dimintions				Birim Ağırlık Unit Weight
			a	b	c	d	
YMK B68HB	68mm Hibrit Bilyalı Barel	50	68	26	10	32	235 gr
YMK B68HBS	68mm Hibrit Bilyalı Barel Saten	50	68	26	10	32	235 gr
YMK B68HBG	68mm Hibrit Bilyalı Barel Seti	20	68	26	10	32	429 gr
YMK B68HBGS	68mm Hibrit Bilyalı Barel Seti Saten	20	68	26	10	32	429 gr
YMK B68HBK	68mm Hibrit Bilyalı Barel Kutulu	120	68	26	10	32	235 gr

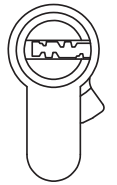
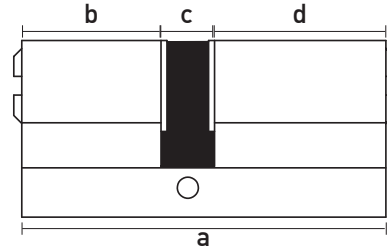
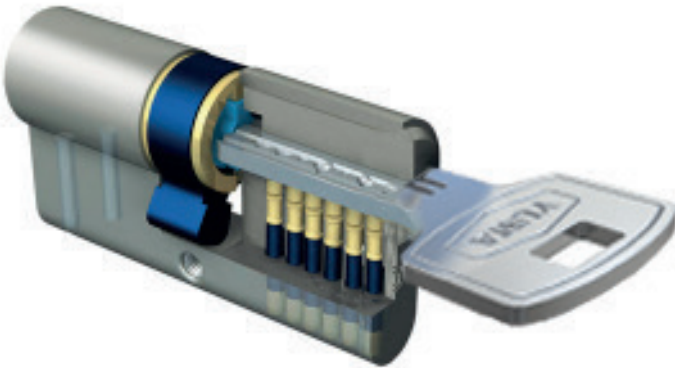

hibrit



Teknik Özellikler

- Piriç Tüp ve Anahtar
- Zamak Gövde
- Paslanmaz Yaylar
- Dijital Teknoloji Anahtar Kombinasyonu
- Saten / Nikel Kaplama Gövde
- Opsiyonel Pass Sistem

Specifications

- Brass Tube and Key
- Zinc Body
- INOX (Stainless Steel) Springs
- Digital Key Combination
- Satin / Nickel Plating Optional
- Pass System Available



Model Code	Ürün Cinsi Description	Koli İçi Adet Bundle Piece	Ölçüler Dimintions				Birim Ağırlık Unit Weight
			a	b	c	d	
YMK B68H	68mm Hibrit Cerman Barel	120	68	26	10	32	192 gr
YMK B68HS	68mm Hibrit Cerman Barel Saten	120	68	26	10	32	192 gr
YMK 90HS	90mm Hibrit Cerman Barel Saten	96	90	35	10	45	229 gr

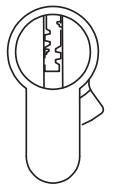
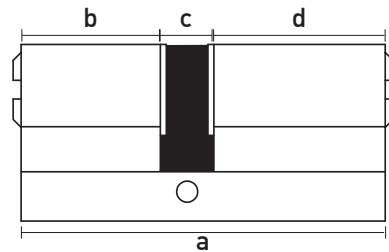
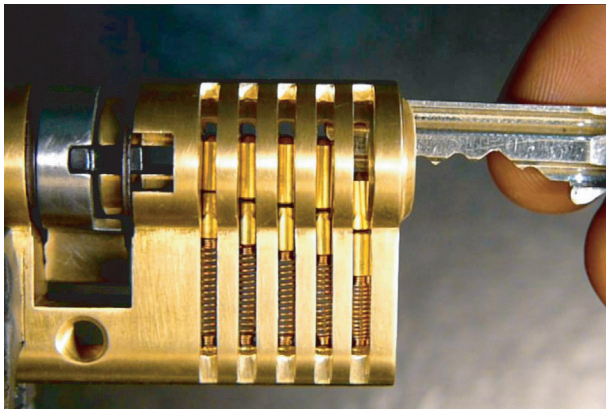

hibrit

HİBRİT MANDALLI BAREL / SİLİNDİR HYBRID CYLINDER WITH KNOB



Pass Sistem Anahtar
Key Alike Available

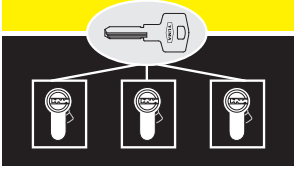

TS EN 1303



Teknik Özellikler

- Pirinç Tüp ve Anahtar
- Zamak Gövde
- Paslanmaz Yaylar
- Dijital Teknoloji Anahtar Kombinasyonu
- Saten / Nikel Kaplama Gövde
- Opsiyonel Pass Sistem

Specifications

- Brass Tube and Key
- Zinc Body
- INOX (Stainless Steel) Springs
- Digital Key Combination
- Satin / Nickel Plating Optional
- Pass System Available



Model Code	Ürün Cinsi Description	Koli İçi Adet Bundle Piece	Ölçüler Dimintions				Birim Ağırlık Unit Weight
			a	b	c	d	
YMK B68HM	68mm Hibrit Cerman Mandallı Barel	30	68	26	10	32	176 gr
YMK B68HMS	68mm Hibrit Cerman Mandallı Barel Saten	30	68	26	10	32	176 gr
YMK B68HBM	68mm Hibrit Bilyalı Mandallı Barel	30	68	26	10	32	220 gr
YMK B68HBMS	68mm Hibrit Bilyalı Mandallı Barel Saten	30	68	26	10	32	220 gr
YMK B68HMK	68mm Hibrit Cerman Mandallı Barel Kutulu	72	68	26	10	32	176 gr
YMK B68HBMK	68mm Hibrit Bilyalı Mandallı Barel Kutulu	72	68	26	10	32	220 gr
YMK B90HMSK	90mm Hibrit Cerman Mandallı Barel Saten Kutulu	60	90	35	10	45	218 gr
YMK B90HBMSK	90mm Hibrit Bilyalı Mandallı Barel Saten Kutulu	60	90	35	10	45	230 gr

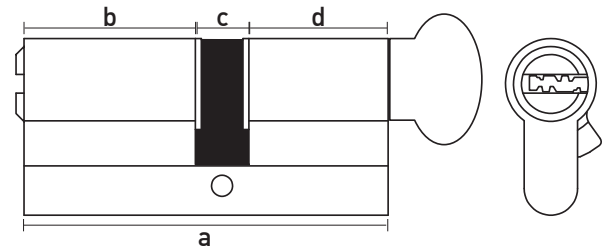
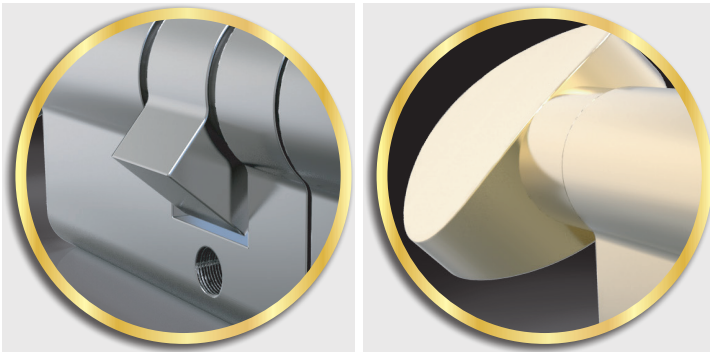

hibrit



Teknik Özellikler

- Galvaniz Sac Gövde
- Nikel Kaplamalı Kare Ayna ve Karşılık
- Opsiyonel: Oval-Krom/Saten/Sarı Kaplama Ayna
- Zamak Sürgü ve Mandal

Specifications

- Galvanized Sheet Metal Case.
- Nickel Plated Square Forehead and Striking
- Striking (Optional: Ovoid-Chrome/Satin/Gold Plated)
- Zinc Alloy Deadbolt and Latch

HİBRİT SİLİNDİRLİ GÖMME DAİRE KİLİTLERİ * MORTISE LOCK WITH HYBRID CYLINDER

Model Code	Ürün Cinsi Description	Koli İçi Adet Bundle Piece	Ölçüler Dimentions						Birim Ağırlık Unit Weight
			a	b	c	d	e	f	
YMK 620	20x85mm AL. Pvc Doğrama Hibrit Silindirli Gömme Kilit	30	20	240	173	85	23	2	499 gr
YMK 621	25x85mm AL. Pvc Doğrama Hibrit Silindirli Gömme Kilit	30	25	240	173	85	23	2	515 gr
YMK 635H	35x85mm Hibrit Silindirli Daire Kilit	30	35	240	176	85	23	2	749 gr
YMK 640H	40x85mm Hibrit Silindirli Daire Kilit	30	40	240	176	85	23	2	779 gr
YMK 645H	45x85mm Hibrit Silindirli Daire Kilit	30	45	240	176	85	23	2	799 gr
YMK 645HB.3M	45x85mm 3 Millli Hibrit Silindirli Daire Kiliti - Bilyalı	30	45	240	176	85	23	2	862 gr
YMK 645HC.3M	45x85mm 3 Millli Hibrit Silindirli Daire Kiliti - Cerman	30	45	240	176	85	23	2	820 gr

HİBRİT İÇ KAPI ODA GÖMME KİLİTLER * HBYRID INTERIOR MORTISE LOCK

Model Code	Ürün Cinsi Description	Koli İçi Adet Bundle Piece	Ölçüler Dimentions						Birim Ağırlık Unit Weight
			a	b	c	d	e	f	
YM 604H	35x90mm Hibrit Oda Kiliti	40	35	240	176	90	23	2	586,5 gr
YM 613H	40x90mm Hibrit Oda Kiliti	40	40	240	176	90	23	2	612 gr
YM614H	45x90mm Hibrit Oda Kiliti	40	45	240	176	90	23	2	625 gr

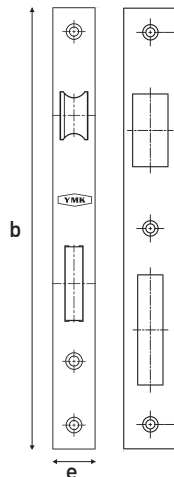
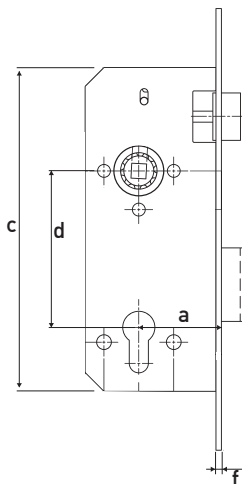

hibrit

EKO BİSİKLET KİLİDİ *ECO BICYCLE LOCK



Model Code	Ürün Cinsi Description	Koli İçi Adet Bundle Piece	Birim Ağırlık Unit Weight
YMK 732	Bisiklet Kilidi	120	100 gr.

EKO KAPI HİDROLİĞİ * ECO HYDRAULIC DOOR CLOSER



Model Code	Ürün Cinsi Description	Koli İçi Adet Bundle Piece	Yük Kapasitesi Dimentions	Birim Ağırlık Unit Weight
YMK 742	2 Numara Kapı Hidroliği	10	25 - 45 kg.	993 gr.
YMK 743	3 Numara Kapı Hidroliği	10	45 - 65 kg.	1187 gr.
YMK 744	4 Numara Kapı Hidroliği	10	60 - 85 kg.	1690 gr.

TOPUZLU KİLİT * KNOB LOCK



Model Code	Ürün Cinsi Description	Koli İçi Adet Bundle Piece	Birim Ağırlık Unit Weight
YMK 731	Topuzlu Kilit	40	491 gr.



KİLİT

Güvenliđi teknoloji ile
buluřturan tecrübe...

YUMA KİLİT
ve MAK. SAN. A.Ő.

Terazidere Mah. Güneř Cad.
Rüya Sk. No:7
Bayrampařa / İSTANBUL
Tel: +90 212 576 19 82
+90 212 493 33 19
Fax : +90 212 493 33 18
info@yumakilit.com.tr
www.yumakilit.com.tr

